

Features

- XTREMELY Low Jitter
- Low Cost
- XPRESS Delivery
- Frequency Resolution to six decimal places
- Stabilities to ± 50 PPM
- -20 to +70°C or -40 to +85°C operating temperatures
- Tri-State Enable / Disable Feature
- Industry Standard Package, Footprint & Pin-Out
- Fully RoHS compliant
- Gold over Nickel Termination Finish
- Serial ID with Comprehensive Traceability

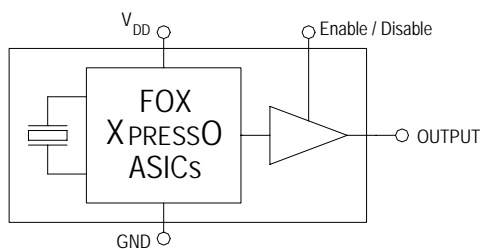

For more information -- Click on the drawing

Description

The Fox XPRESSO Crystal Oscillator is a breakthrough in configurable Frequency Control Solutions. XPRESSO utilizes a family of proprietary ASICs, designed and developed by Fox, with a key focus on noise reduction technologies.

The 3rd order Delta Sigma Modulator reduces noise to the levels that are comparable to traditional Bulk Quartz and SAW oscillators. The ASICs family has ability to select the output type, input voltages, and temperature performance features.

With the XPRESS lead-time, low cost, low noise, wide frequency range, excellent ambient performance, XpressO is an excellent choice over the conventional technologies.

Finished XPRESSO parts are 100% final tested.



Applications

- ANY application requiring an oscillator
- SONET
- Ethernet
- Storage Area Network
- Broadband Access
- Microprocessors / DSP / FPGA
- Industrial Controllers
- Test and Measurement Equipment
- Fiber Channel

Contents

	page
Model Selection & Part Number Guide	2
Electrical Characteristic	3
Absolute Maximums	4
Output Wave Characteristics	4
Phase Noise	5
Jitter	5
Pin Assignment	6
Recommended Circuit	6
Reflow	6
Mechanical Drawing and Pad Layout	7
Tape and Reel Specification	8
Label	8
Traceability – LOT Number & Serial Identification	9
SGS Report	10~13
Mechanical Test	14
Burn-In Test	14
MTTF / FITS calculations	15
Fox Contact Information	16

Model Selection Guide & Fox Part Number

STEP #1: Customer selects the Model Description and provides to Fox Customer Service

Model Description

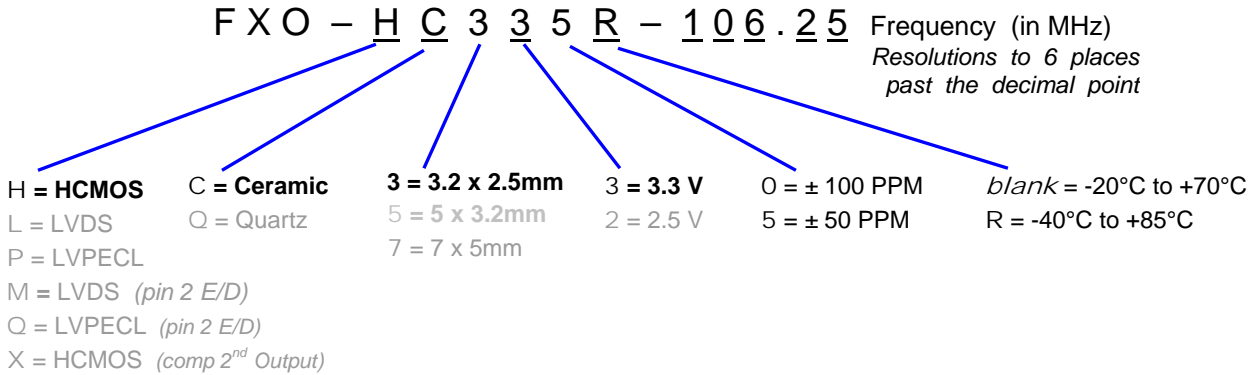

STEP #2: The Fox Customer Service team provides a customer specific Part Number for use on their Bill Of Materials (BOM).

Fox Part Number (The assigned Fox Part Number must be on the BOM – not the above Model Description)
(This will ensure receipt of the proper part)

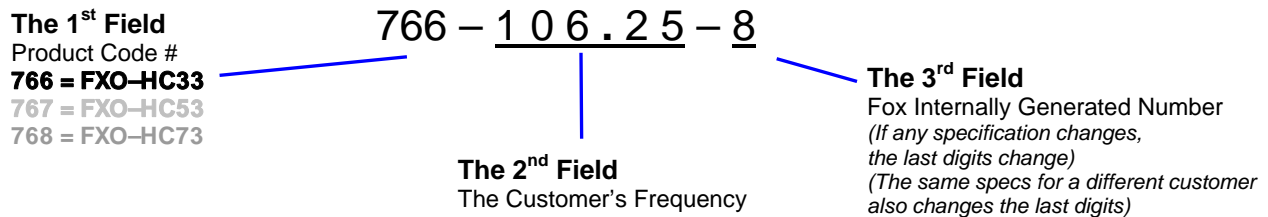

This example, **FXO-HC335R-106.25** = HCMOS Output, Ceramic 3.2 x 2.5mm Package, 3.3V, ±50 PPM Stability, -40 to +85°C Temperature Range, at 106.25 MHz

Electrical Characteristics			
Parameters	Symbol	Condition	Maximum Value (unless otherwise noted)
Frequency Range	F _O		0.750 to 250.000 MHz
Frequency Stability ¹			100, 50 ppm
Temperature Range	T _O	Standard operating	-20°C to +70°C
	T _{STG}	Optional operating Storage	-40°C to +85°C -55°C to +125°C
Supply Voltage	V _{DD}	Standard	3.3 V ± 5%
Input Current (@ 15pF LOAD)	I _{DD}	0.75 ~ 20 MHz	32 mA
		20+ ~ 50 MHz	35 mA
		50+ ~ 130 MHz	47 mA
		130+ ~ 200 MHz	55 mA
		200+ ~ 250 MHz	60 mA
Output Load	HCMOS	Standard	15 pF
		Operational To 125MHz	30 pF
Start-Up Time	T _S		10 mS
Output Enable / Disable Time			100 nS
Moisture Sensitivity Level	MSL	JEDEC J-STD-20	1
Termination Finish			Au

Note 1 – Stability is inclusive of 25°C tolerance, operating temperature range, input voltage change, load change, aging, shock and vibration.

Absolute Maximum Ratings (Useful life may be impaired. For user guidelines only, not tested)			
Parameters	Symbol	Condition	Maximum Value (unless otherwise noted)
Input Voltage	V _{DD}		-0.5V to +5.0V
Operating Temperature	T _{AMAX}		-55°C to +105°C
Storage Temperature	T _{STG}		-55°C to +125°C
Junction Temperature			150°C
ESD Sensitivity	HBM	Human Body Model	>1 kV

Output Wave Characteristics

Parameters	Symbol	Condition	Maximum Value (unless otherwise noted)
Output LOW Voltage	V_{OL}	0.75 to 150 MHz 150+ to 250 MHz	10% V_{DD} 20% V_{DD}
Output HIGH Voltage	V_{OH}	0.75 to 150 MHz 150+ to 250 MHz	90% V_{DD} MIN 80% V_{DD} MIN
Output Symmetry (See Drawing Below)		@ 50% V_{DD} Level	45% ~ 55%
Output Enable (PIN # 1) Voltage	V_{IH}		$\geq 70\% V_{DD}$
Output Disable (PIN # 1) Voltage	V_{IL}		$\leq 30\% V_{DD}$
Cycle Rise Time (See Drawing Below)	T_R	0.75 to 150 MHz 150+ to 250 MHz	3 nS (10%~90%) 3 nS (20%~80%)
Cycle Fall Time (See Drawing Below)	T_F	0.75 to 150 MHz 150+ to 250 MHz	3 nS (90%~10%) 3 nS (80%~20%)

*If 30% to 70% times are used, Rise and Fall times change to 1.5 nS from 0.75 to 250MHz
If 20% to 80% times are used, Rise and Fall times change to 2 nS from 0.75 to 150MHz*

Rise Time / Fall Time Measurements

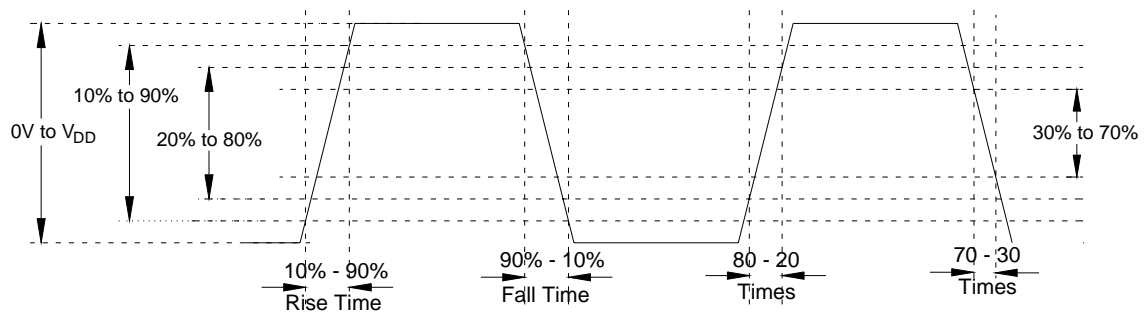

Oscillator Symmetry

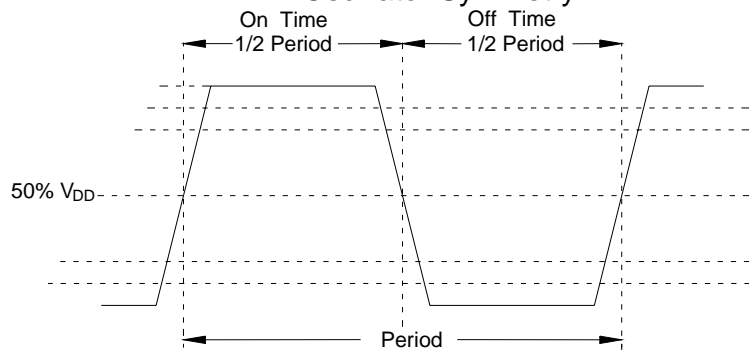

Ideally, Symmetry should be 50/50 -- Other expressions are 45/55 or 55/45

Phase Noise

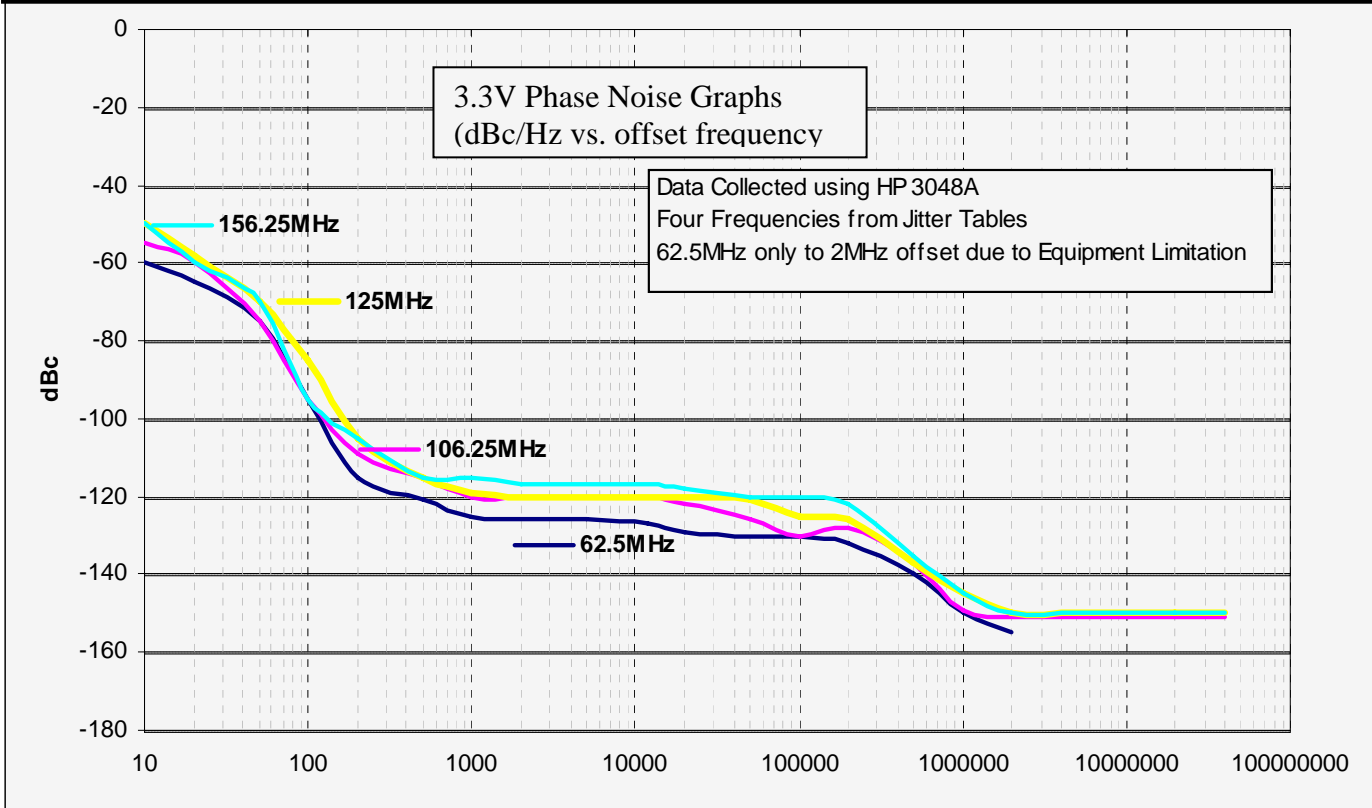

Jitter is frequency dependent. Below are typical values at select frequencies.

Phase Jitter & Time Interval Error (TIE)

Frequency	Phase Jitter (12kHz to 20MHz)	TIE (Sigma of Jitter Distribution)	Units
62.5 MHz	0.8	2.9	pS RMS
106.25 MHz	0.8	3.2	pS RMS
125 MHz	0.8	2.3	pS RMS
156.25 MHz	1.0	3.0	pS RMS

Phase Jitter is integrated from HP3048 Phase Noise Measurement System; measured directly into 50 ohm input; $V_{DD} = 3.3V$.

TIE was measured on LeCroy LC684 Digital Storage Scope, directly into 50 ohm input, with Amherst M1 software; $V_{DD} = 3.3V$.

Per *MJSQ spec (Methodologies for Jitter and Signal Quality specifications)*

Random & Deterministic Jitter Composition

Frequency	Random (Rj) (pS RMS)	Deterministic (Dj) (pS P-P)	Total Jitter (Tj) (14 x Rj) + Dj
62.5 MHz	1.2	9.2	25.6 pS
106.25 MHz	1.3	9.0	27.2 pS
125 MHz	1.2	8.7	26.5 pS
156.25 MHz	1.2	12.7	30.0 pS

Rj and Dj, measured on LeCroy LC684 Digital Storage Scope, directly into 50 ohm input, with Amherst M1 software.

Per *MJSQ spec (Methodologies for Jitter and Signal Quality specifications)*

Pin Description and Recommended Circuit

Pin #	Name	Type	Function
1	E / D ¹	Logic	Enable / Disable Control of Output (0 = Disabled)
2	GND	Ground	Electrical Ground for V _{DD}
3	Output	Output	HCMOS Oscillator Output
4	V _{DD} ²	Power	Power Supply Source Voltage
Test Points	N. C.	Hi Z	No Connection (Factory Use ONLY)

NOTES:

- ¹ Includes pull-up resistor to V_{DD} to provide output when the pin (1) is No Connect.
- ² Installation should include a 0.01μF bypass capacitor placed between V_{DD} (Pin 4) and GND (Pin 2) to minimize power supply line noise.

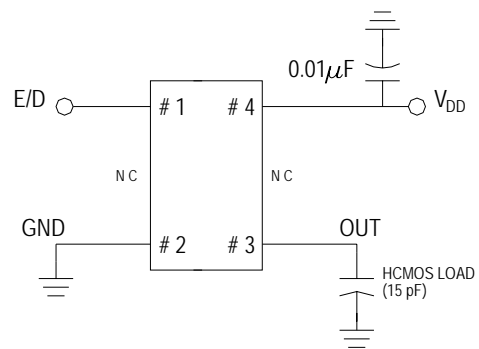
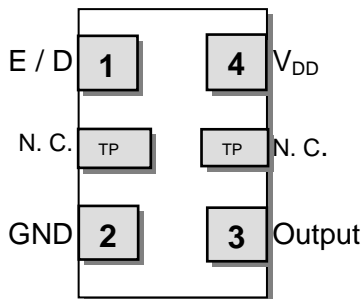

Terminations as viewed from the Top

NOTE: XPRESSO HCMOS XO's are designed to fit on Industry Standard, 4 pad layouts

Enable / Disable Control

Pin # 1 (state)	Output (Pin # 3)
OPEN (No Connection)	ACTIVE Output
"1" Level $V_{IH} \geq 70\% V_{DD}$	ACTIVE Output
"0" Level $V_{IL} \leq 30\% V_{DD}$	High Impedance

Soldering Reflow Profile (2 times Maximum at 260°C for 10 seconds MAX)

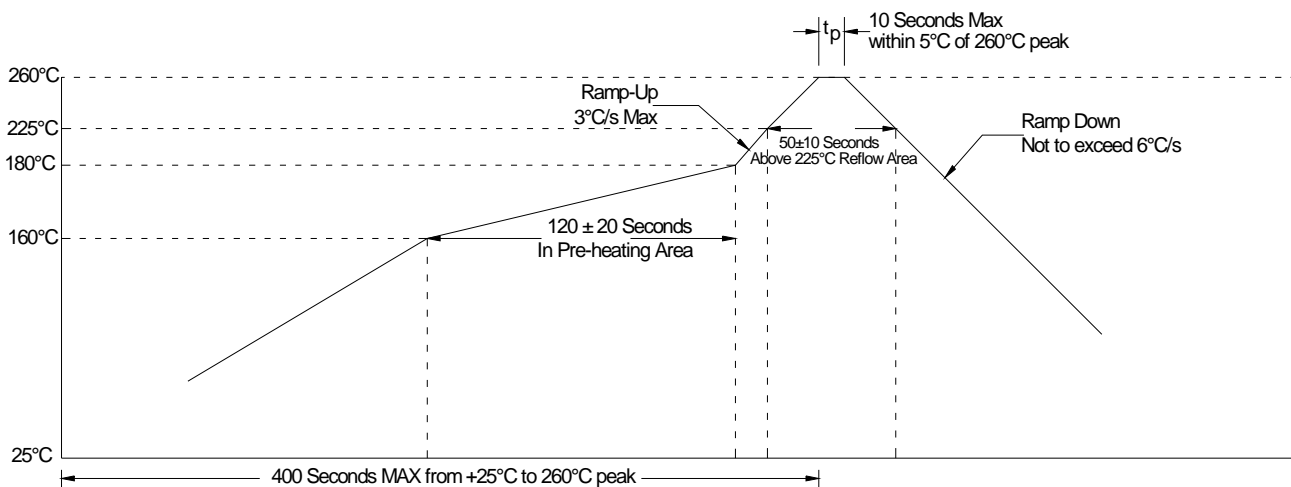

Mechanical Dimensional Drawing & Pad Layout

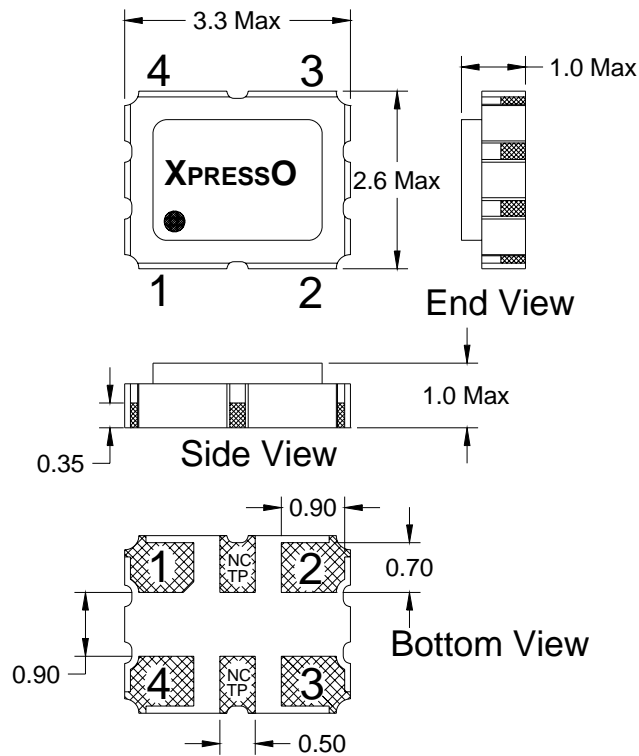

Actual part marking is depicted.
See **Traceability** (pg. 8) for more information

Recommended Solder Pad Layout

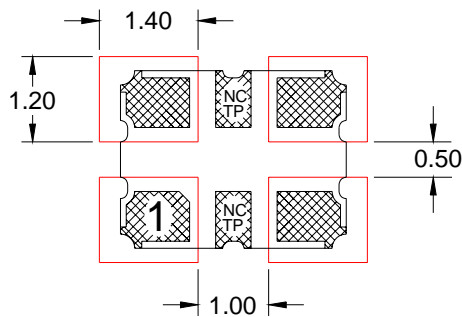

Note: XpressO HCMOS XO's are designed to fit on industry standard, 4 pad layouts.

Pin Connections

- # 1 E / D # 3 V_{OUT}
- # 2 GND # 4 V_{DD}

Drawing is for reference to critical specifications defined by size measurements. Certain non-critical visual attributes, such as side castellations, reference pin shape, etc. may vary

Tape and Reel Dimensions

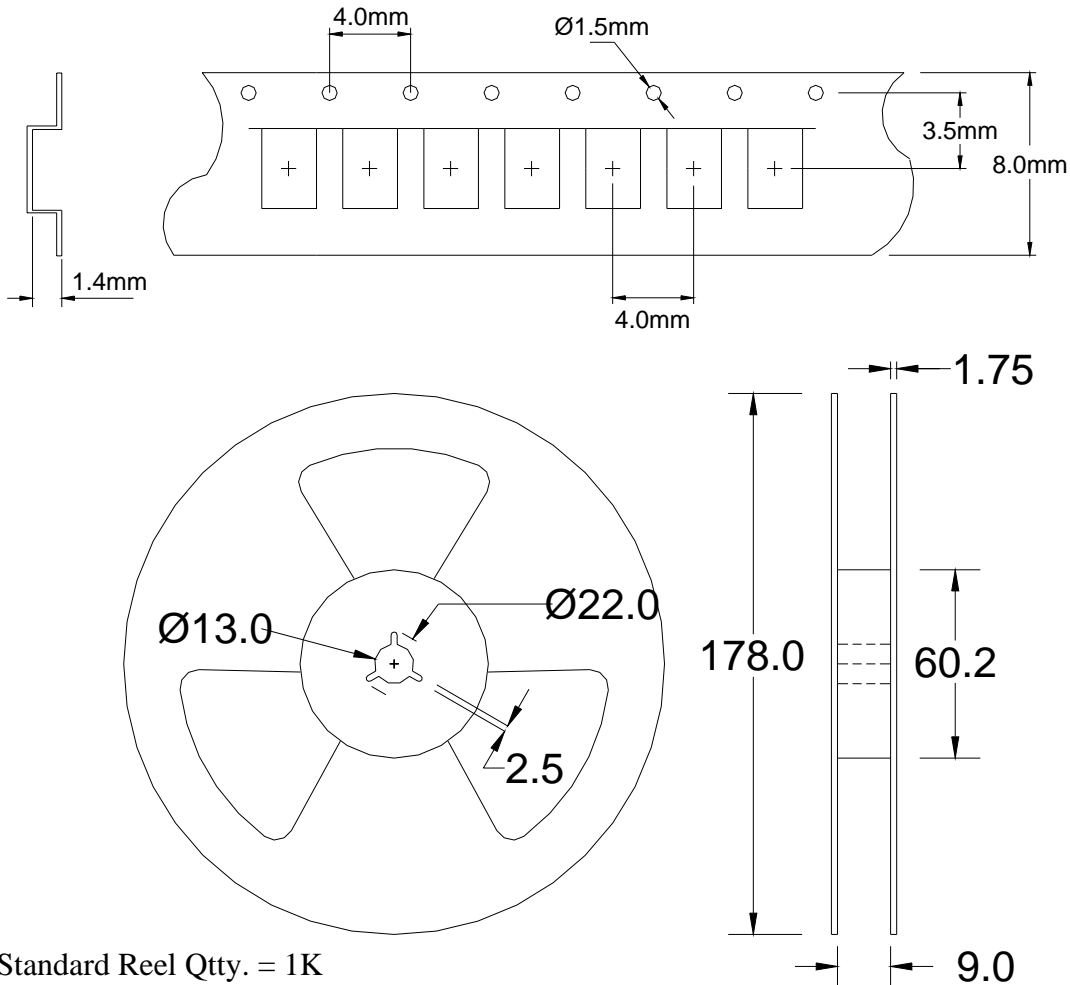

Standard Reel Qty. = 1K

Labeling (Reels and smaller packaging are labeled with the below)

- Fox Part Number: **766-106.25-8** →
- Quantity: **1000** pieces →
- Description: **FXO-HC335R-106.25** →
- Date Code: **0745** →
(YYWW 2007 45th wk)
- LOT #: **24435** →
If traceability should become necessary

An additional identification code is contained internally if tracking should ever be necessary

Traceability – LOT Number & Serial Identification

LOT Number

The LOT Number has direct ties to the customer purchase order. The LOT Number is marked on the “Reel” label, and also stored internally on non-volatile memory inside the XPRESSO part. XPRESSO parts that are shipped Tape and Reel, are also placed in an Electro Static Discharge (ESD) bag and will have the LOT Number labeled on the exterior of the ESD bag.

It is recommended that the XPRESSO parts remain in this ESD bag during storage for protection and identification.

If the parts become separated from the label showing the LOT Number, it can be retrieved from inside one of the parts, and the information that can be obtained is listed below:

- Customer Purchase Order Number
- Internal Fox Sales Order Number
- Dates that the XPRESSO part was shipped from the factory
- The assigned customer part number
- The specification that the part was designed for

Serial Identification

The Serial ID is the individualized information about the configuration of that particular XPRESSO part. The Serial ID is unique for each and every XPRESSO part, and can be read by special Fox equipment.

With the Serial ID, the below information can be obtained about that individual, XPRESSO part:

- Equipment that the XPRESSO part was configured on
- Raw material used to configure the XPRESSO part
- Traceability of the raw material back to the foundries manufacturing lot
- Date and Time that the part was configured
- Any optimized electrical parameters based on customer specifications
- Electrical testing of the actual completed part
- Human resource that was monitoring the configuration of the part

Fox has equipment placed at key Fox locations World Wide to read the Lot Identification and Serial Number of any XPRESSO part produced and can then obtain the information from above within 24 hours

3rd Party (SGS) Material Report



Test Report

No. : CE/2008/63138 Date : 2008/06/19 Page : 1 of 4

FOX ELECTRONICS
5570 ENTERPRISE PARKWAY FT. MYERS, FL 33905, USA



The following sample(s) was/were submitted and identified by/on behalf of the client as :

Sample Description	:	XPRESSO CERAMIC OSCILLATORS
Style/Item No.	:	SEAM SEAL CLOCK OSCILLATOR
Buyer/Order No.	:	47454
Sample Receiving Date	:	2008/06/12
Testing Period	:	2008/06/12 TO 2008/06/19

=====

Test Result(s) : Please refer to next page(s).

Chenyu Kung / Operation Manager
Signed for and on behalf of
SGS TAIWAN LTD.
Chemical Laboratory – Taipei

Unless otherwise stated the results shown in this test report refer only to the sample(s) tested. This test report cannot be reproduced, except in full, without prior written permission of the Company. 除非另有說明，此報告結果僅對測試之樣品負責。本報告未經本公司書面許可，不可部份複製。
This Test Report is issued by the Company under its General Conditions of Service printed overleaf or available on request and accessible at http://www.sgs.com/terms_and_conditions.htm. Attention is drawn to the limitation of liability, indemnification and jurisdiction issues defined therein. Any holder of this Test Report is advised that information contained hereon reflects the Company's findings at the time of its intervention only and within the limits of Client's instructions, if any. The Company's sole responsibility is to its Client and this document does not exonerate parties to a transaction from exercising all their rights and obligations under the transaction documents. Any unauthorized alteration, forgery or falsification of the content or appearance of this document is unlawful and offenders may be prosecuted to the fullest extent of the law.

SGS Taiwan Ltd. 台灣檢驗科技股份有限公司	No. 33 Wu Chyuan Road, Wuku Industrial Zone, Taipei County, Taiwan / 台北縣五股工業區五權路 33 號 t (886-2) 2299-3939	f (886-2) 2299-3237	www.tw.sgs.com
--	--	---------------------	----------------

Member of the SGS Group



3rd Party (SGS) Material Report (continued)



Test Report

No. : CE/2008/63138 Date : 2008/06/19 Page : 2 of 4

FOX ELECTRONICS
5570 ENTERPRISE PARKWAY FT. MYERS, FL 33905, USA



Test Result(s)

PART NAME NO.1 : MIXED ALL PARTS

Test Item (s):	Unit	Method	MDL	Result
				No.1
Cadmium (Cd)	mg/kg	With reference to IEC 62321/2nd CDV (111/95/CDV). Determination of Cadmium by ICP-AES.	2	n.d.
Lead (Pb)	mg/kg	With reference to IEC 62321/2nd CDV (111/95/CDV). Determination of Lead by ICP-AES.	2	n.d.
Mercury (Hg)	mg/kg	With reference to IEC 62321/2nd CDV (111/95/CDV). Determination of Mercury by ICP-AES.	2	n.d.
Hexavalent Chromium Cr(VI) by alkaline extraction	mg/kg	With reference to IEC 62321/2nd CDV (111/95/CDV). Determination of Hexavalent Chromium for non-metallic samples by UV/Vis Spectrometry.	2	n.d.
Halogen	---	With reference to BS EN 14582:2007. Analysis was performed by IC method for F , Cl , Br , I content.	---	---
Halogen-Fluorine (F) (CAS No.: 007782-41-4)	mg/kg	With reference to BS EN 14582:2007. Analysis was performed by IC method for Fluorine content.	50	n.d.
Halogen-Chlorine (Cl) (CAS No.: 007782-50-5)	mg/kg	With reference to BS EN 14582:2007. Analysis was performed by IC method for Chlorine content.	50	n.d.
Halogen-Bromine (Br) (CAS No.: 007726-95-6)	mg/kg	With reference to BS EN 14582:2007. Analysis was performed by IC method for Bromine content.	50	n.d.
Halogen-Iodine (I) (CAS No.: 007553-56-2)	mg/kg	With reference to BS EN 14582:2007. Analysis was performed by IC method for Iodine content.	50	n.d.

Unless otherwise stated the results shown in this test report refer only to the sample(s) tested. This test report cannot be reproduced, except in full, without prior written permission of the Company. 除非另有說明，此報告結果僅對測試之樣品負責。本報告未經本公司書面許可，不可部份複製。
This Test Report is issued by the Company under its General Conditions of Service printed overleaf or available on request and accessible at http://www.sgs.com/terms_and_conditions.htm. Attention is drawn to the limitation of liability, indemnification and jurisdiction issues defined therein. Any holder of this Test Report is advised that information contained hereon reflects the Company's findings at the time of its intervention only and within the limits of Client's instructions, if any. The Company's sole responsibility is to its Client and this document does not exonerate parties to a transaction from exercising all their rights and obligations under the transaction documents. Any unauthorized alteration, forgery or falsification of the content or appearance of this document is unlawful and offenders may be prosecuted to the fullest extent of the law.

SGS Taiwan Ltd. No. 33 Wu Chyuan Road, Wuku Industrial Zone, Taipei County, Taiwan / 台北縣五股工業區五權路 33 號
台灣檢驗科技股份有限公司 t (886-2) 2299-3939 f (886-2) 2299-3237 www.tw.sgs.com

Member of the SGS Group



3rd Party (SGS) Material Report (continued)

Z



Test Report

No. : CE/2008/63138 Date : 2008/06/19 Page : 3 of 4

FOX ELECTRONICS
5570 ENTERPRISE PARKWAY FT. MYERS, FL 33905, USA



Test Item (s):	Unit	Method	MDL	Result
				No.1
Sum of PBBs			-	n.d.
Monobromobiphenyl			5	n.d.
Dibromobiphenyl			5	n.d.
Tribromobiphenyl			5	n.d.
Tetrabromobiphenyl			5	n.d.
Pentabromobiphenyl			5	n.d.
Hexabromobiphenyl			5	n.d.
Heptabromobiphenyl			5	n.d.
Octabromobiphenyl			5	n.d.
Nonabromobiphenyl			5	n.d.
Decabromobiphenyl			5	n.d.
Sum of PBDEs (Mono to Nona)	mg/kg	With reference to IEC 62321/2nd CDV (111/95/CDV). Determination of PBB and PBDE by GC/MS.	-	n.d.
Monobromodiphenyl ether			5	n.d.
Dibromodiphenyl ether			5	n.d.
Tribromodiphenyl ether			5	n.d.
Tetrabromodiphenyl ether			5	n.d.
Pentabromodiphenyl ether			5	n.d.
Hexabromodiphenyl ether			5	n.d.
Heptabromodiphenyl ether			5	n.d.
Octabromodiphenyl ether			5	n.d.
Nonabromodiphenyl ether			5	n.d.
Decabromodiphenyl ether			5	n.d.
Sum of PBDEs (Mono to Deca)			-	n.d.

- Note :
1. mg/kg = ppm
 2. n.d. = Not Detected
 3. MDL = Method Detection Limit.
 4. "--" = Not Conducted
 5. "- " = Not Regulated
 6. The sample(s) was/were analyzed on behalf of the applicant as mixing sample in one testing.
The above result(s) was/were only given as the informality value.

Unless otherwise stated the results shown in this test report refer only to the sample(s) tested. This test report cannot be reproduced, except in full, without prior written permission of the Company. 除非另有說明，此報告結果僅對測試之樣品負責，本報告未經本公司書面許可，不可部份複製。
This Test Report is issued by the Company under its General Conditions of Service printed overleaf or available on request and accessible at http://www.sgs.com/terms_and_conditions.htm. Attention is drawn to the limitation of liability, indemnification and jurisdiction issues defined therein. Any holder of this Test Report is advised that information contained hereon reflects the Company's findings at the time of its intervention only and within the limits of Client's instructions, if any. The Company's sole responsibility is to its Client and this document does not exonerate parties to a transaction from exercising all their rights and obligations under the transaction documents. Any unauthorized alteration, forgery or falsification of the content or appearance of this document is unlawful and offenders may be prosecuted to the fullest extent of the law.

SGS Taiwan Ltd. No. 33 Wu Chyuan Road, Wuku Industrial Zone, Taipei County, Taiwan / 台北縣五股工業區五權路 33 號
台灣檢驗科技股份有限公司 t (886-2) 2299-3939 f (886-2) 2299-3237 www.tw.sgs.com

Member of the SGS Group



3rd Party (SGS) Material Report (continued)



Test Report

No. : CE/2008/63138 Date : 2008/06/19 Page : 4 of 4

FOX ELECTRONICS
5570 ENTERPRISE PARKWAY FT. MYERS, FL 33905, USA



** End of Report **

Unless otherwise stated the results shown in this test report refer only to the sample(s) tested. This test report cannot be reproduced, except in full, without prior written permission of the Company. 除非另有說明，此報告結果僅對測試之樣品負責。本報告未經本公司書面許可，不可部份複製。
This Test Report is issued by the Company under its General Conditions of Service printed overleaf or available on request and accessible at http://www.sgs.com/terms_and_conditions.htm. Attention is drawn to the limitation of liability, indemnification and jurisdiction issues defined therein. Any holder of this Test Report is advised that information contained hereon reflects the Company's findings at the time of its intervention only and within the limits of Client's instructions, if any. The Company's sole responsibility is to its Client and this document does not exonerate parties to a transaction from exercising all their rights and obligations under the transaction documents. Any unauthorized alteration, forgery or falsification of the content or appearance of this document is unlawful and offenders may be prosecuted to the fullest extent of the law.

SGS Taiwan Ltd. No. 33 Wu Chyuan Road, Wuku Industrial Zone, Taipei County, Taiwan / 台北縣五股工業區五權路 33 號
台灣檢驗科技股份有限公司 t (886-2) 2299-3939 f (886-2) 2299-3237 www.tw.sgs.com

Member of the SGS Group

Mechanical Testing

Parameter	Test Method
Mechanical Shock	Drop from 75cm to hardwood surface – 3 times
Mechanical Vibration	10~55Hz, 1.5mm amplitude, 1 Minute Sweep 2 Hours each in 3 Directions (X, Y, Z)
High Temperature Burn-in	Under Power @ 125°C for 2000 Hours (results below)
Hermetic Seal	He pressure: 4 ±1 kgf / cm ² 2 Hour soak

2,000 Hour Burn-In

Burn-In Testing – under power 2000 Hours, 125°C

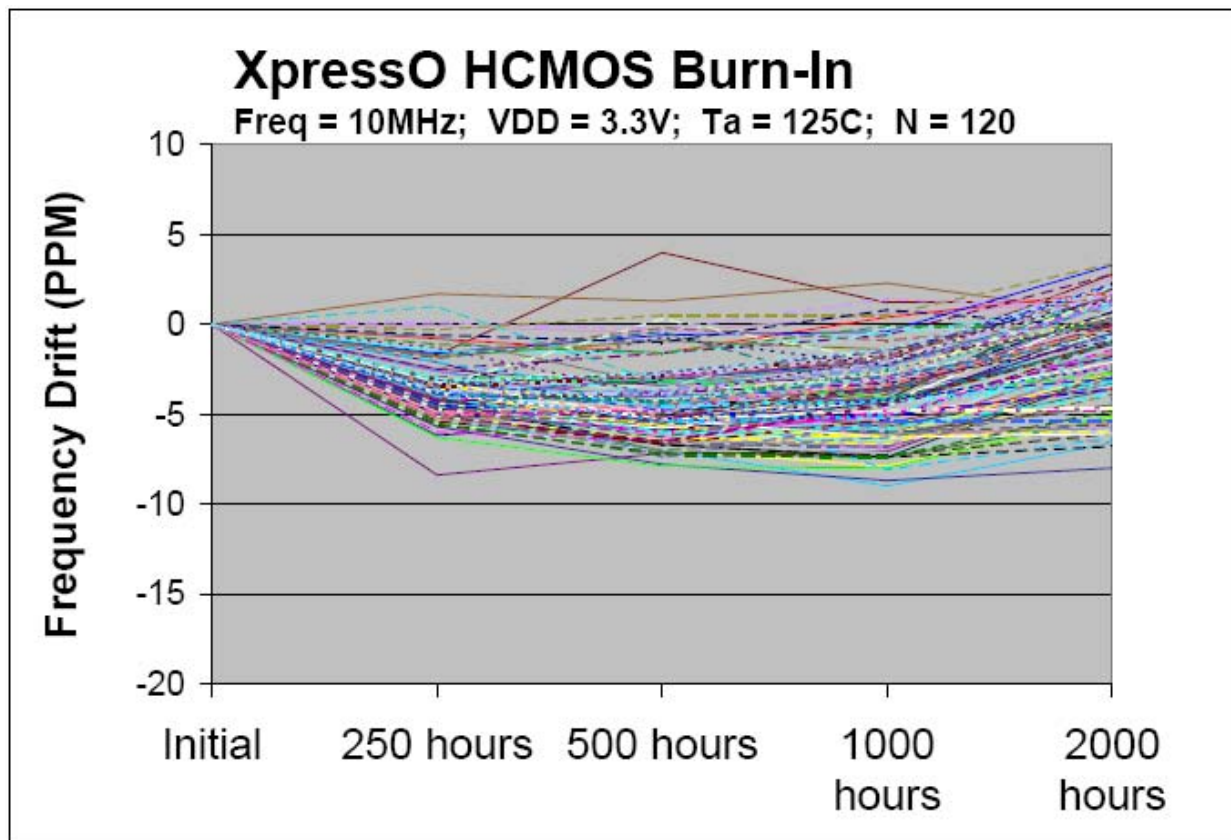

MTTF / FITS Calculations

Products are grouped together by process for MTTF calculations.
 (All XpressO output and package types are manufactured with the same process)

Number of Parts Tested: 360 (120 of each output type: HCMOS, LVDS, LVPECL)
Number of Failures: 0
Test Temperature: 125°C
Number of Hours: 2000

MTTF was calculated using the following formulas:

[1.] Device Hours (*devhrs*) = (number of devices) x (hours at elevated temperature in °K)

$$[2.] MTTF = \frac{devhrs \times af \times 2}{\chi^2}$$

$$[3.] FITS = \frac{1}{MTTF} * 10^9$$

Where:

Label	Name	Formula/Value
<i>af</i>	Acceleration Factor	$e^{\left(\frac{eV}{k}\right) \times \left(\frac{1}{t_1} - \frac{1}{t_2}\right)}$
<i>eV</i>	Activation Energy	0.40 V
<i>k</i>	Bolzman's Constant	8.62 X 10 ⁻⁵ eV/°K
<i>t₁</i>		Operating Temperature (°K)
<i>t₂</i>		Accelerated Temperature (°K)
Θ	Theta	Confidence Level (60% industry standard)
<i>r</i>	Failures	Number of failed devices
χ^2	Chi-Square	statistical significance for bivariate tabular analysis [table look-up] based on assumed Θ (Theta – confidence) and number of failures (<i>r</i>) For zero failures (60% Confidence): $\chi^2 = 1.830$

$$DEVICE-HOURS = 360 \times 2000 \text{ HOURS} = 720,000$$

$$ACCELERATION FACTOR = e^{\left(\frac{0.40}{8.625}\right) \times \left(\frac{1}{298} - \frac{1}{398}\right)} = 49.91009$$

$$MTTF = \frac{720,000 \times 49.91009 \times 2}{1.833} = 39,209,238 \text{ Hours}$$

$$\text{Failure Rate} = \frac{1.833}{720,000 \times 49.91009 \times 2} = 2.55E-8$$

$$FITS = \text{Failure Rate} * 1E9 = 26$$

Notes :

Patent Numbers:
US 6,664,860, US 5,960,403, US 5,952,890; US 5,960,405; US 6,188,290;
Foreign Patents: R.S.A. 98/0866, R.O.C. 120851; Singapore 67081, 67082; EP 0958652
China ZL 98802217.6, Malaysia MY-118540-A, Philippines 1-1998-000245, Hong Kong #HK1026079, Mexico #232179
US and Foreign Patents Pending
XpressO® Fox Electronics

The above specifications, having been carefully prepared and checked, is believed to be accurate at the time of publication; however, no responsibility is assumed by Fox Electronics for inaccuracies.

Contact Information**(USA)-Worldwide Headquarters**

Tel: 888-GET-2-FOX
Outside US: +1.239.693.0099,
Fax: +1.239.693.1554

Fox Japan

Tel: +81.3.3374.2079,
Fax: +81.3.3377.5221

Fox Hong Kong

Tel: +852.2854.4285,
Fax: +852.2854.4282

Fox EMEA

Tel/Fax: +44.1767.312632